



# MAGNETIC LIGHT

**MAGNETIC LIGHT :** The magnetic lighting system is a combination product, mainly composed of below parts: track, lamp body, and switching power supply. With magnetic attraction technology, the lamp components are adsorbed on the track. The track uses a low-voltage power supply, and the driver is very small.



The number of lights can be increased or decreased freely without any tools onto the magnetic lamp track.

All of the lights on the rail can be free movement. You can move the position of each light at any time according to your needs.

Compared with the 110V 220V magnetic LED track light, it is a DC48V Magnetic track lighting system, it is safe even if you touch it when it is working.

# Magnetic Light



## ■ Technical Specification

	LV-MGLF-6W	LV-MGLF-12W	LV-MGLF-18W
Power:	6W	12W	18W
Luminous: <small>flux [Lm]</small>	90 lm/w	90 lm/w	90 lm/w
CRI:	>90	>90	>90
Input Voltage:	48V	48V	48V
Chip:	Osram	Osram	Osram
Dimensions:	L110*H25mm	L220*H25 mm	L330*H25 mm
EAN	6925222090643	6925222090667	6925222090681

## ■ Technical Drawing and Features

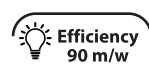
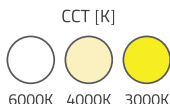
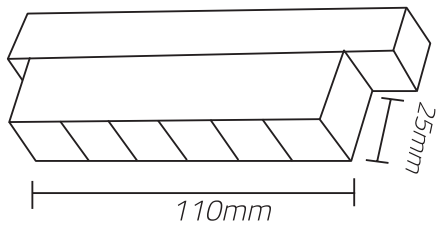
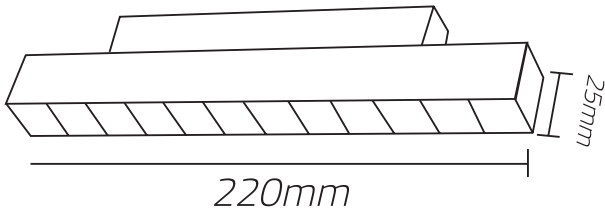

Application  Shopping market  Restaurant  Office  House

LV -

MGL

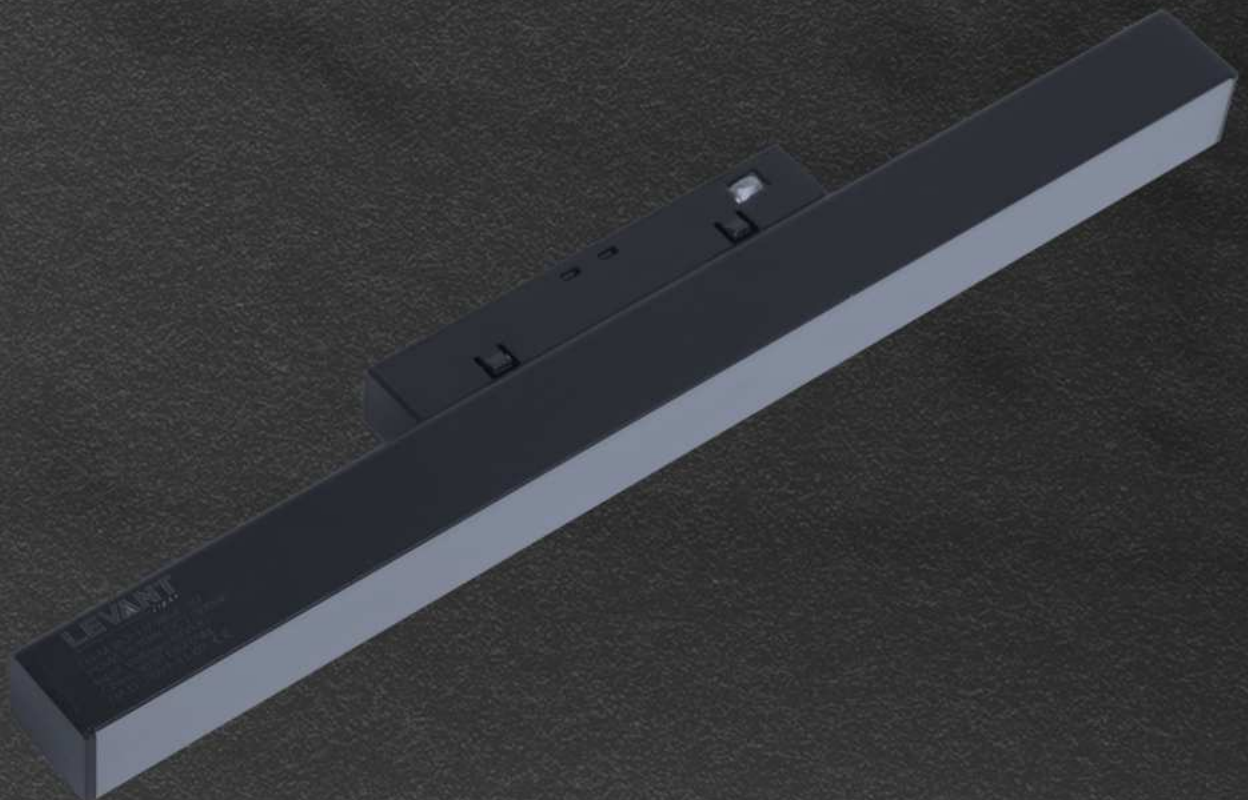

## ■ Technical Specification

	LV-MGL-30	LV-MGL-60	LV-MGL-90	LV-MGL-120
Power:	12W	24W	36W	48W
Luminous: flux [Lm]	90 lm/w	90 lm/w	90 lm/w	90 lm/w
CRI:	>90	>90	>90	>90
Input Voltage:	48V	48V	48V	48V
Chip:	Osram	Osram	Osram	Osram
Dimensions:	L300*W22*H38 mm	L600*W22*H38 mm	L900*W22*H38 mm	L1200*W22*H38 mm
EAN	6925222091510	6925222091527	6925222091534	6925222091541

## ■ Technical Drawing and Features

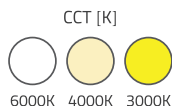
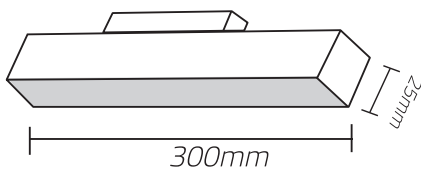
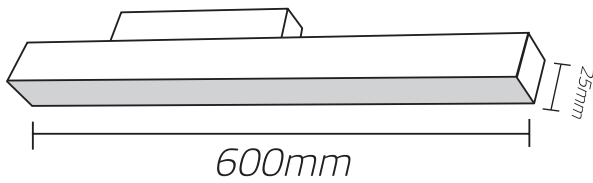

Application  Shopping market  Restaurant  Office  House

# L V - MGLM

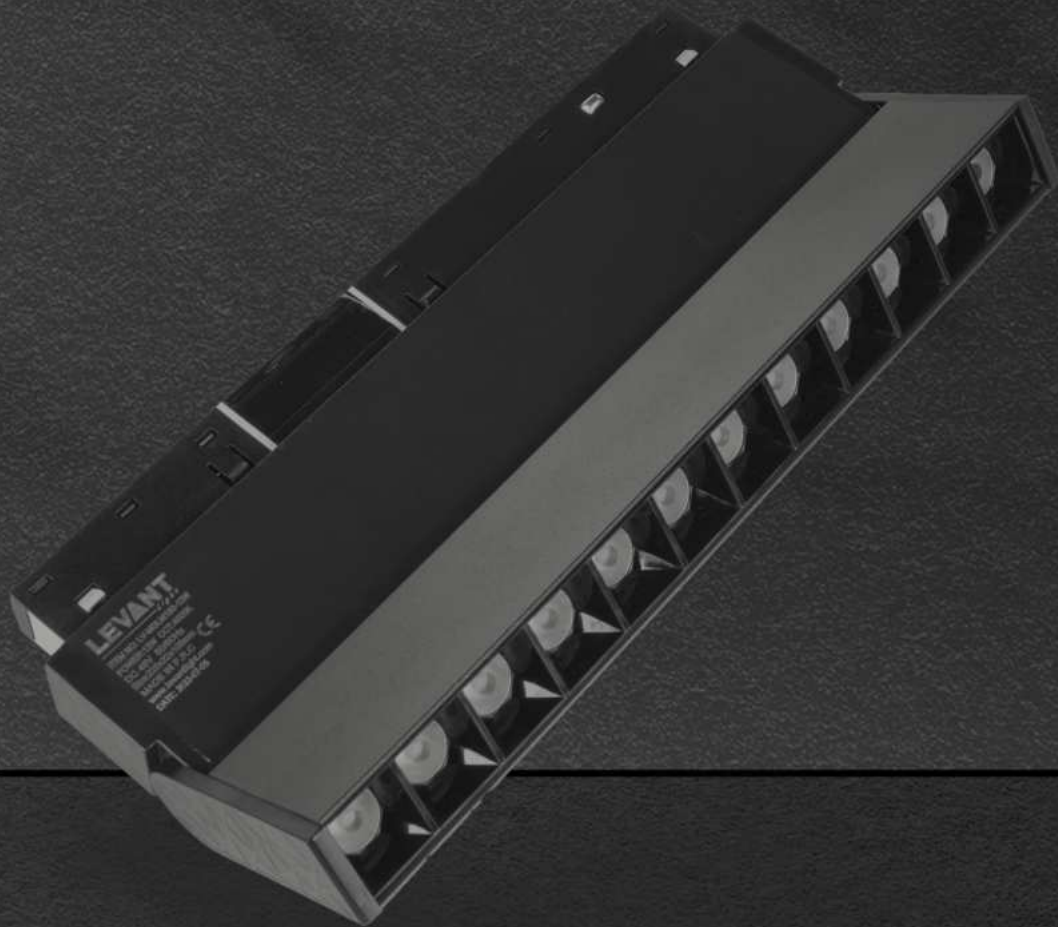

## ■ Technical Specification

	LV-MGLM180-6W	LV-MGLM180-12W	LV-MGLM180-18W	LV-MGLM180-24W
Power:	6W	12W	18W	24W
Luminous: flux [Lm]	90 lm/w	90 lm/w	90 lm/w	90 lm/w
CRI:	>90	>90	>90	>90
Input Voltage:	48V	48V	48V	48V
Chip:	Osram	Osram	Osram	Osram
Dimensions:	L112*W22*H136 mm	L225*W22*H136 mm	L355*W22*H136 mm	L485*W22*H136 mm
EAN	6925222091817	6925222091824	6925222091831	6925222091848

## ■ Technical Drawing and Features

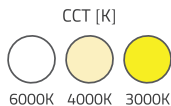
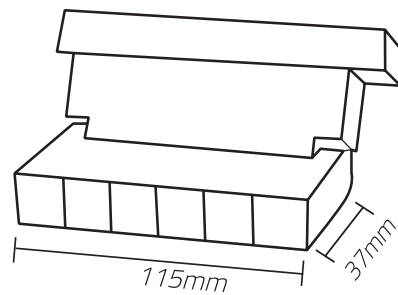
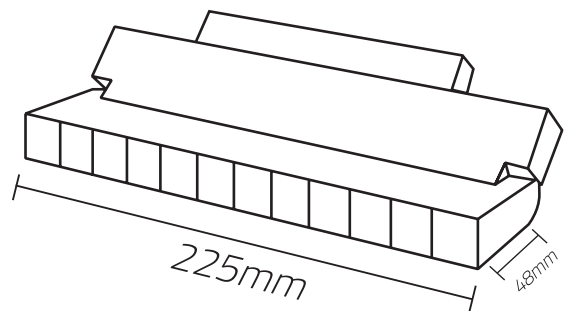

Application Shopping market Restaurant Office House



All of the lights on the rail can be free movement. You can move the position of each light at any time according to your needs.

Compared with the 110V 220V magnetic LED track light, it is a DC48V Magnetic track lighting system, it is safe even if you touch it when it is working.

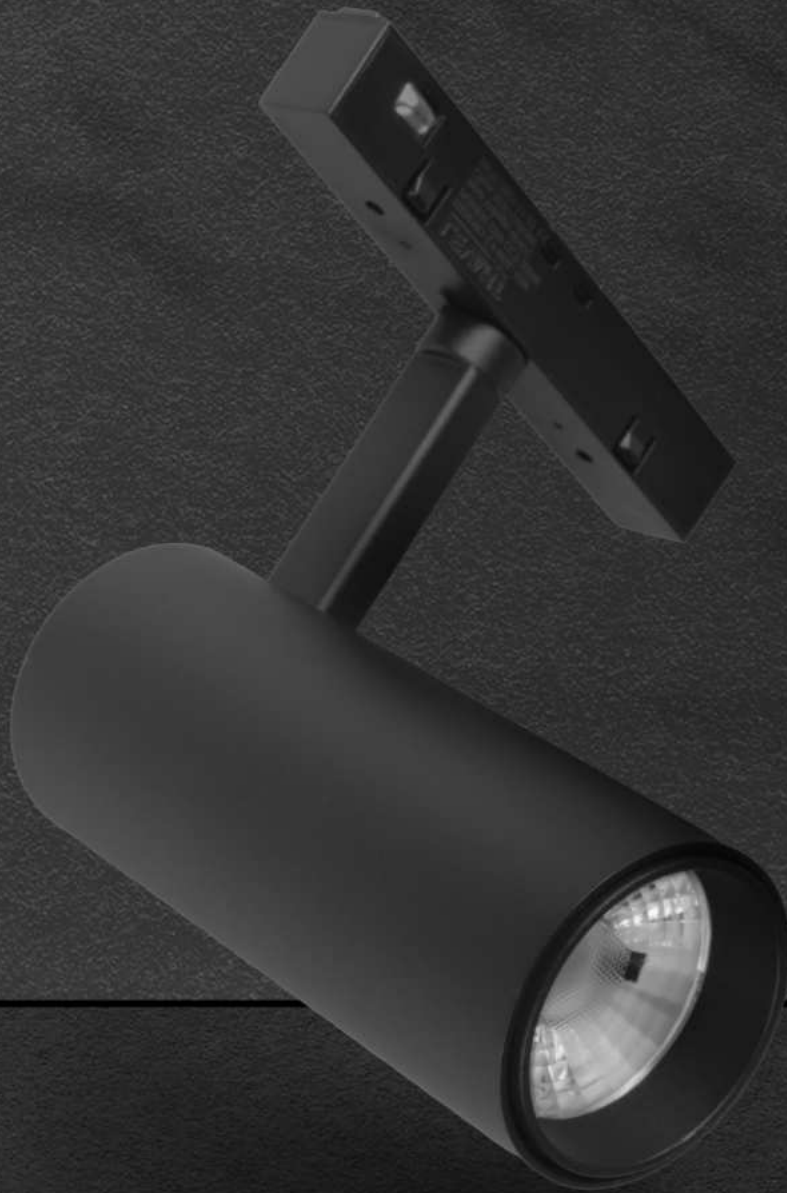

## ■ Technical Specification

	LV-MGLT-7W	LV-MGLT-12W	LV-MGLT-20W	LV-MGLT-30W
Power:	7W	12W	20W	30W
Luminous: flux [Lm]	90 lm/w	90 lm/w	90 lm/w	90 lm/w
CRI:	>90	>90	>90	>90
Input Voltage:	48V	48V	48V	48V
Chip:	Osram	Osram	Osram	Osram
Dimensions:	D38*H70mm	D45*H100mm	D55*H120mm	D65*H140mm
EAN	6925222092005	6925222092012	6925222092036	6925222092043

## ■ Technical Drawing and Features

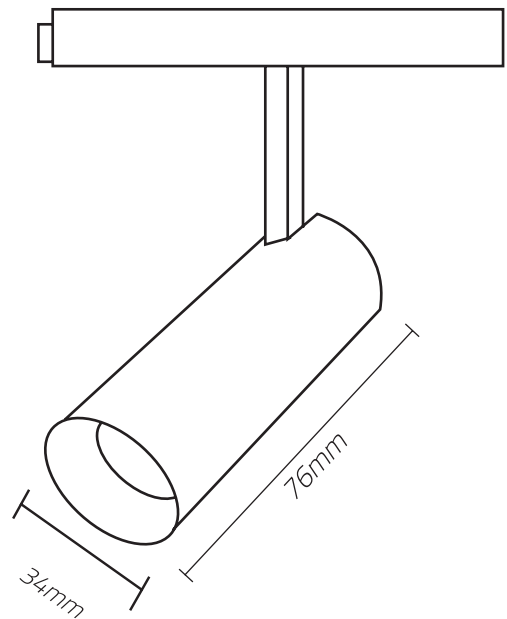

IP20



NO FLICKER

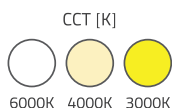

6000K 4000K 3000K

Body color



Life Span  
35000h



Efficiency  
90 lm/w



Application



Shopping market



Restaurant



Office



House

LV-GL-HT



## ■ Technical Specification

	LV-MGL-HT-7W	LV-MGL-HT-12W
Power:	7W	12W
Luminous: flux [Lm]	90 lm/w	90 lm/w
CRI:	>90	>90
Input Voltage:	48V	48V
Chip:	Osram	Osram
Dimension:	D36*H300mm	D46*H300mm
EAN	6925222092203	6925222092210

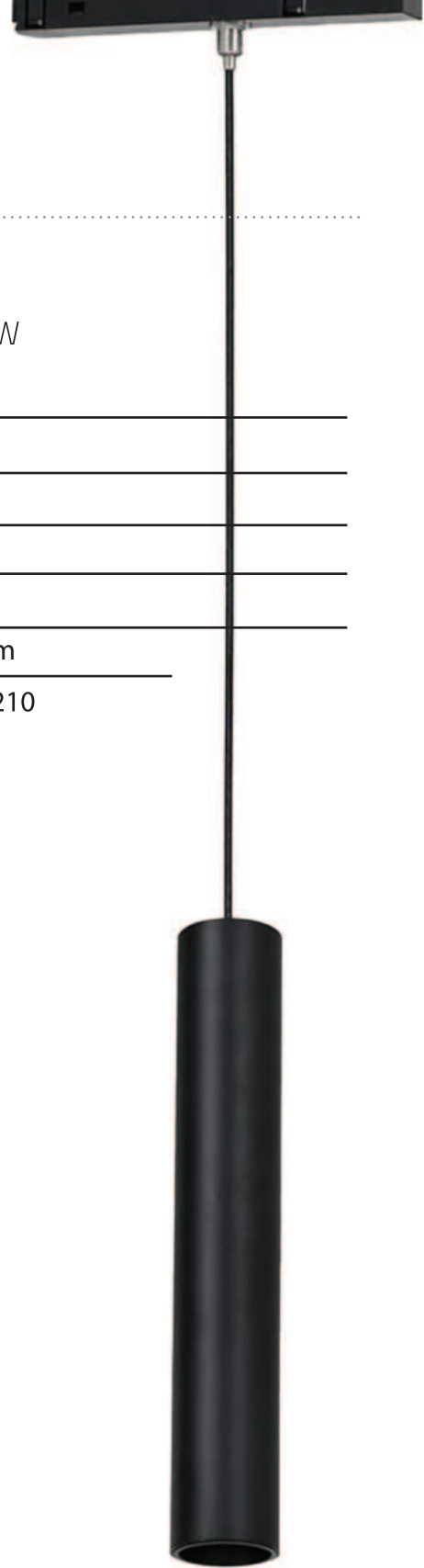

IP20



NO FLICKER

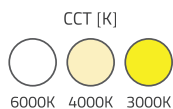

6000K 4000K 3000K

Body color



Life Span  
35000h

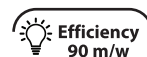

Efficiency  
90 m/w



Application  Shopping market  Restaurant  Office  House



# LEVANT

*Light*

LV-MGL-TFC-12W

MAGNETIC LIGHT



LV-MGL-TFC-12W	
POWER:	12W
Efficiency:	90 lm/w
LUMINOUS: flux [lm]	1080lm
CRI:	$\geq 90$
Beam angle:	36°
Dimension:	Ø145x110xH50mm
IP:	IP20
Material:	Aluminium
Body color:	Black
Input Voltage:	DC 48 V
EAN:	6925222092708

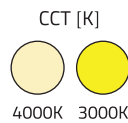

Life Span  
35000h



# LV-MGL-TFC-12W

M A G N E T I C L I G H T





**LEVANT**  
*Light*

LV-MGL-TL





	LV-MGL-TL-12W	LV-MGL-TL-24W	LV-MGL-TL-36W	LV-MGL-TL-48W
POWER:	12W	24W	36W	48W
Efficiency:	90 lm/w	90 lm/w	90 lm/w	90 lm/w
LUMINOUS: flux [lm]	1080lm	2160lm	3240lm	4320lm
CRI:	≥90	≥90	≥90	≥90
Beam angle:	180°	180°	180°	180°
Dimension:	300x22xH65mm	600x22xH65mm	900x22xH65mm	1200x22xH65mm
IP:	IP20	IP20	IP20	IP20
Material:	Aluminium	Aluminium	Aluminium	Aluminium
Body color:	Black	Black	Black	Black
Input Voltage:	DC 48 V	DC 48 V	DC 48 V	DC 48 V
EAN:	6925222092807	6925222092814	6925222092821	6925222092838

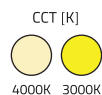
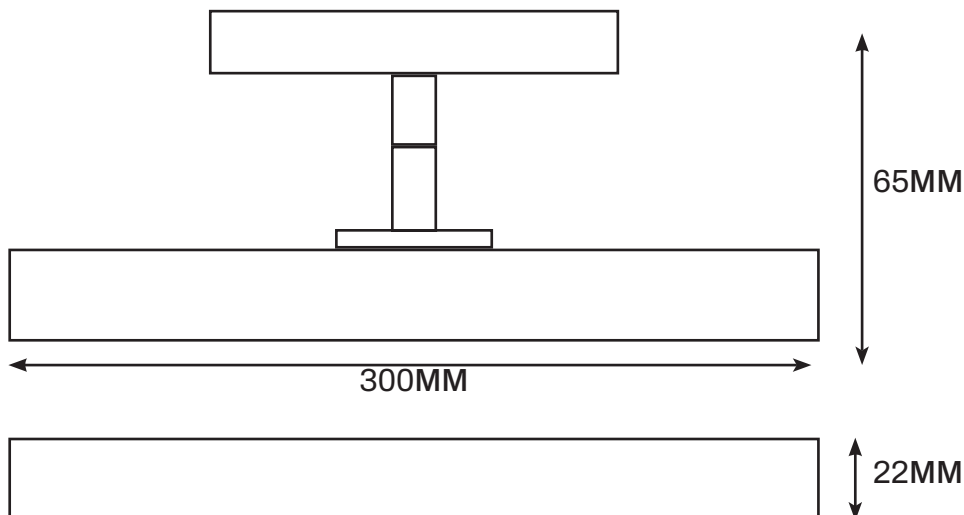



12 W	24 W
36 W	48 W

360°

48V  
DC



# LEVANT

Light

LV-MGL-TF

6 W  
18 W  
12 W  
24 W

360°

48V  
DC



	LV-MGL-TF-6W	LV-MGL-TF-12W	LV-MGL-TF-18W	LV-MGL-TF-24W
POWER:	6W	12W	18W	24W
Efficiency:	90 lm/w	90 lm/w	90 lm/w	90 lm/w
LUMINOUS: flux [lm]	540lm	1080lm	1620lm	2160lm
CRI:	≥90	≥90	≥90	≥90
Beam angle:	180°	180°	180°	180°
Dimension:	110x22xH55mm	220x22xH55mm	325x22xH55mm	425x22xH55mm
IP:	IP20	IP20	IP20	IP20
Material:	Aluminium	Aluminium	Aluminium	Aluminium
Body color:	Black	Black	Black	Black
Input Voltage:	DC 48 V	DC 48 V	DC 48 V	DC 48 V
EAN:	6925222092906	6925222092913	6925222092920	6925222092937

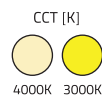
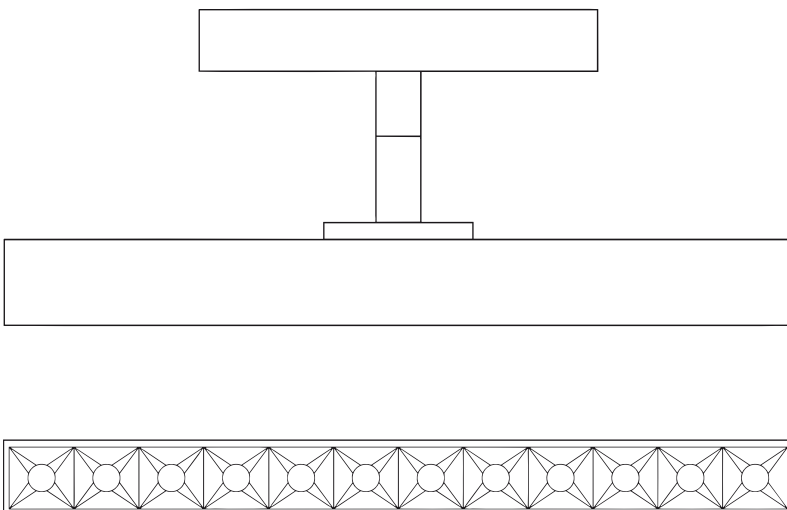



## ■ Technical Specification

LV-MGL-Corner-H

Power:	20W
Luminous: flux [Lm]	90 lm/w
CRI:	>90
Input Voltage:	48V
Chip:	Osram
Dimensions:	315x22x44 mm
EAN	6925222092500

## ■ Features

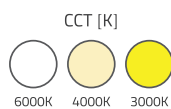

Application



Shopping market



Restaurant



Office



House











## ■ Technical Specification

LV-MGL-Corner-V

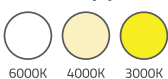
Power:	20W
Luminous: <small>flux [Lm]</small>	90 lm/w
CRI:	>90
Input Voltage:	48V
Chip:	Osram
Dimensions:	315x22x44 mm
EAN	6925222092616

## ■ Features

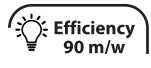

 **IP20**
 **NO FLICKER**
 CCT [K] 6000K 4000K 3000K
  **Body color**
 Life Span **35000h**

 Efficiency **90 lm/w**

Application  Shopping market  Restaurant  Office  House







# MAGNETIC LIGHT RAILS

High quality mounted led magnetic track.

TRACK Surface Magnetic lighting Track, Suspension magnetic rail, Recessed magnetic light track optional.

There are three different installation rails to meet all your different installation requirements.

It is made from the high-grade aluminum extrusions that can be recessed, surface mount, and pendant installation. the track rail has the invisible conductive copper strip on both sides inside the track.

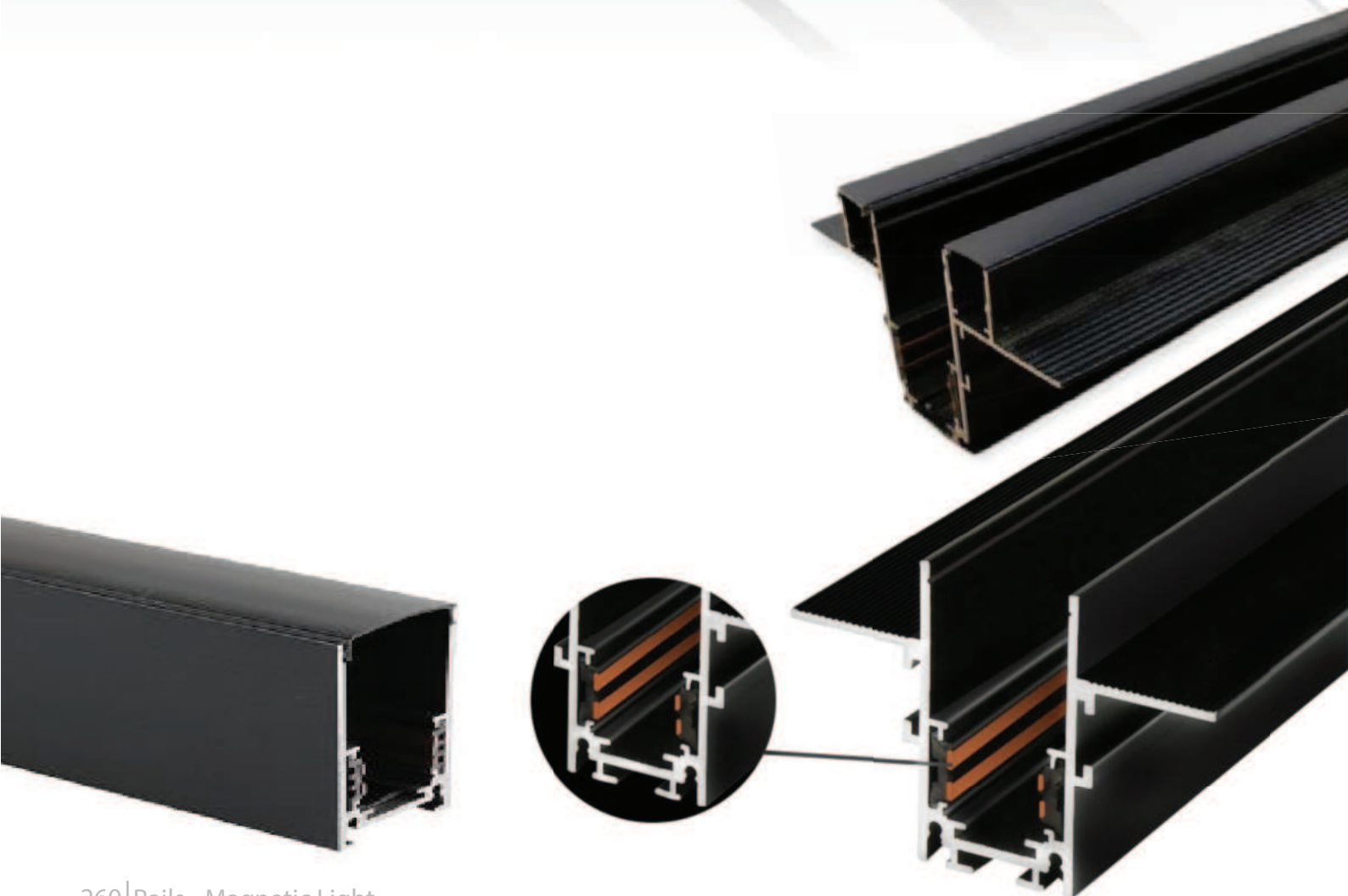

## ■ Dimension [mm]

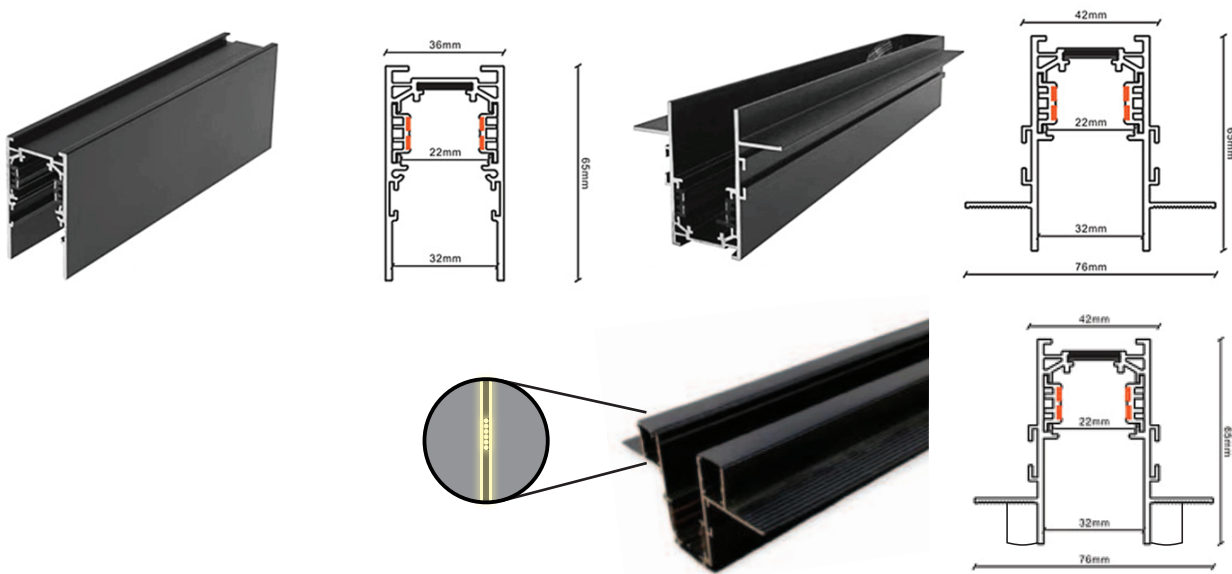

## ■ Technical Specification

	LV-MGR-A	LV-MGR-B	LV-MGR-BD2
COLOR:	● BLK	● BLK	● BLK
Material:	Aluminum	Aluminum	Aluminum
Input Voltage:	48V	48V	48V
Installation:	Apparent	Burial	Burial+ two led rails
IP Rate:	IP 20	IP 20	IP 20
Size:	1M-2M-3M	1M-2M-3M	1M-2M-3M
EAN	6925222093101	6925222093309	6925222093507

## ■ Joints



Ceiling corner joint

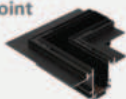

Flat Corner

Wall inner joint



Inner Corner

Wall outer joint



Outer Corner

